

Data Sheet



Article number: 021816025215

Description: Clamp with bracket and rubber
SPGU 6025. 215/30 SK

Measures

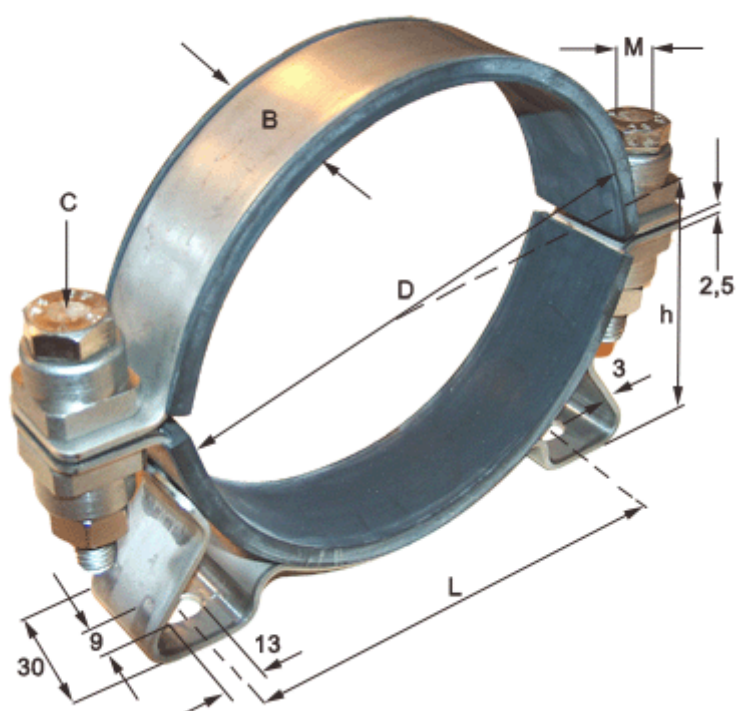

C (screw type) = SK hexagon screw

Diameter D = 215

h = 115

L = 216

Width B = 30